

Summertime 40 (280x280)

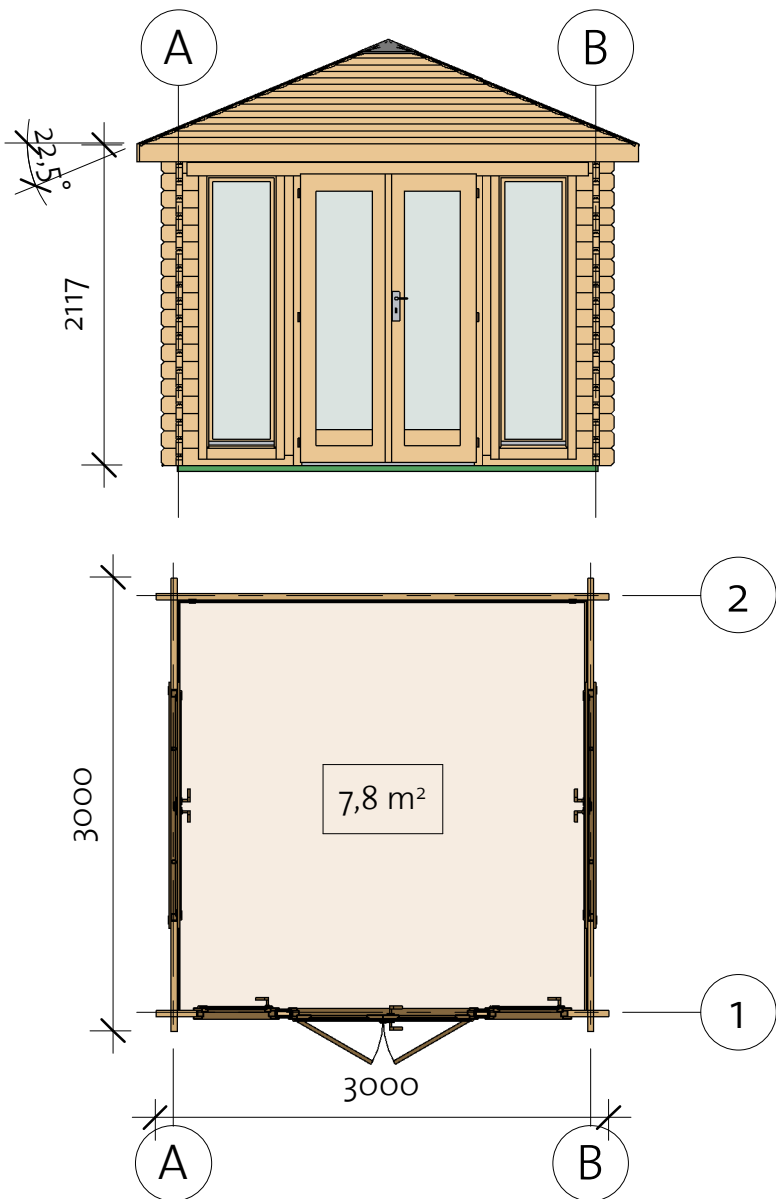

Summertime 40 (280x280)

Foundation

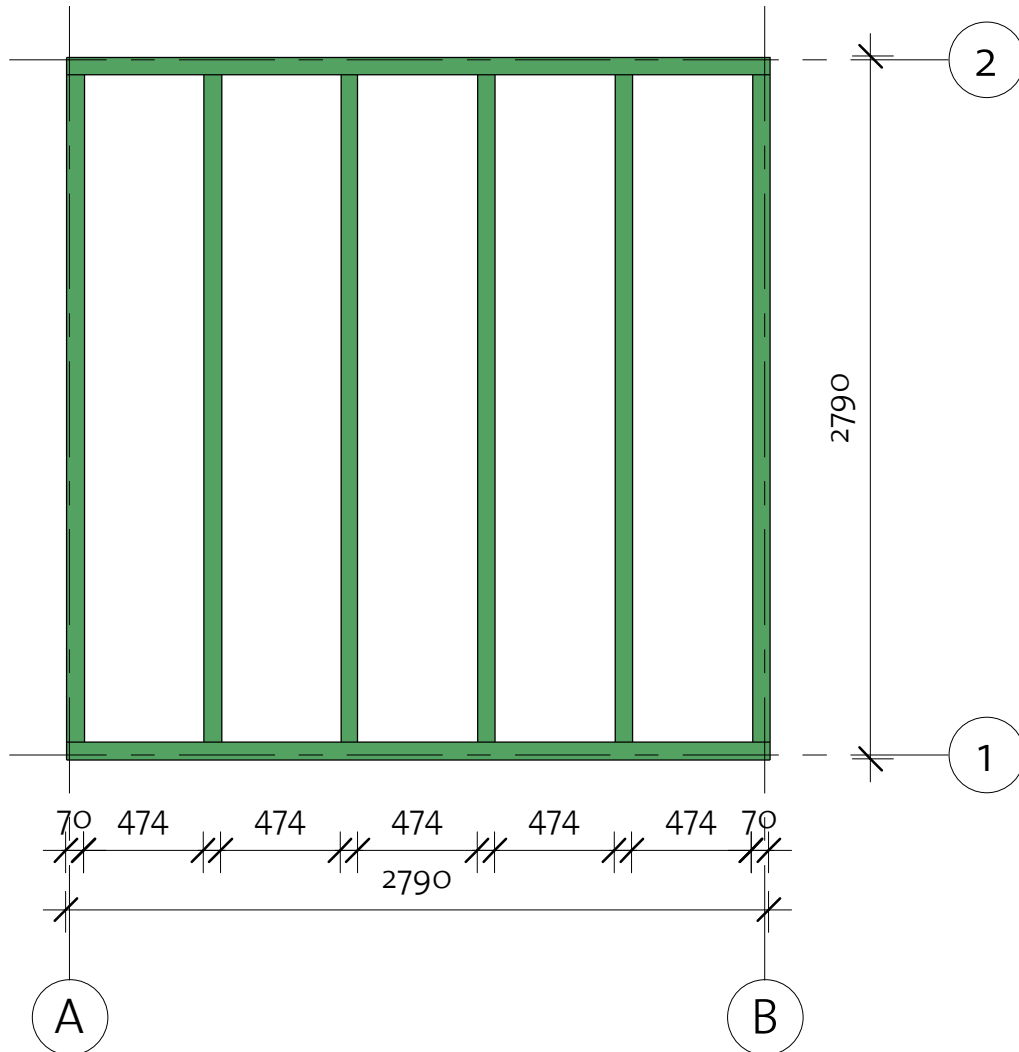

Impregnated foundation beams				
Mark	Type	Profile	Count	Length



IFB1	IFB 70x40		6	2650
IFB2	IFB 70x40		2	2790

Summertime 40 (280x280)

Floor Plan

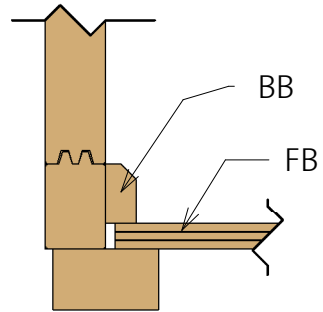
① Baseboard



Floor Schedule				
Mark	Type	Profile	Count	Length
FB	FB 17x114		25	2714
BB	BB 20x40		4	2800

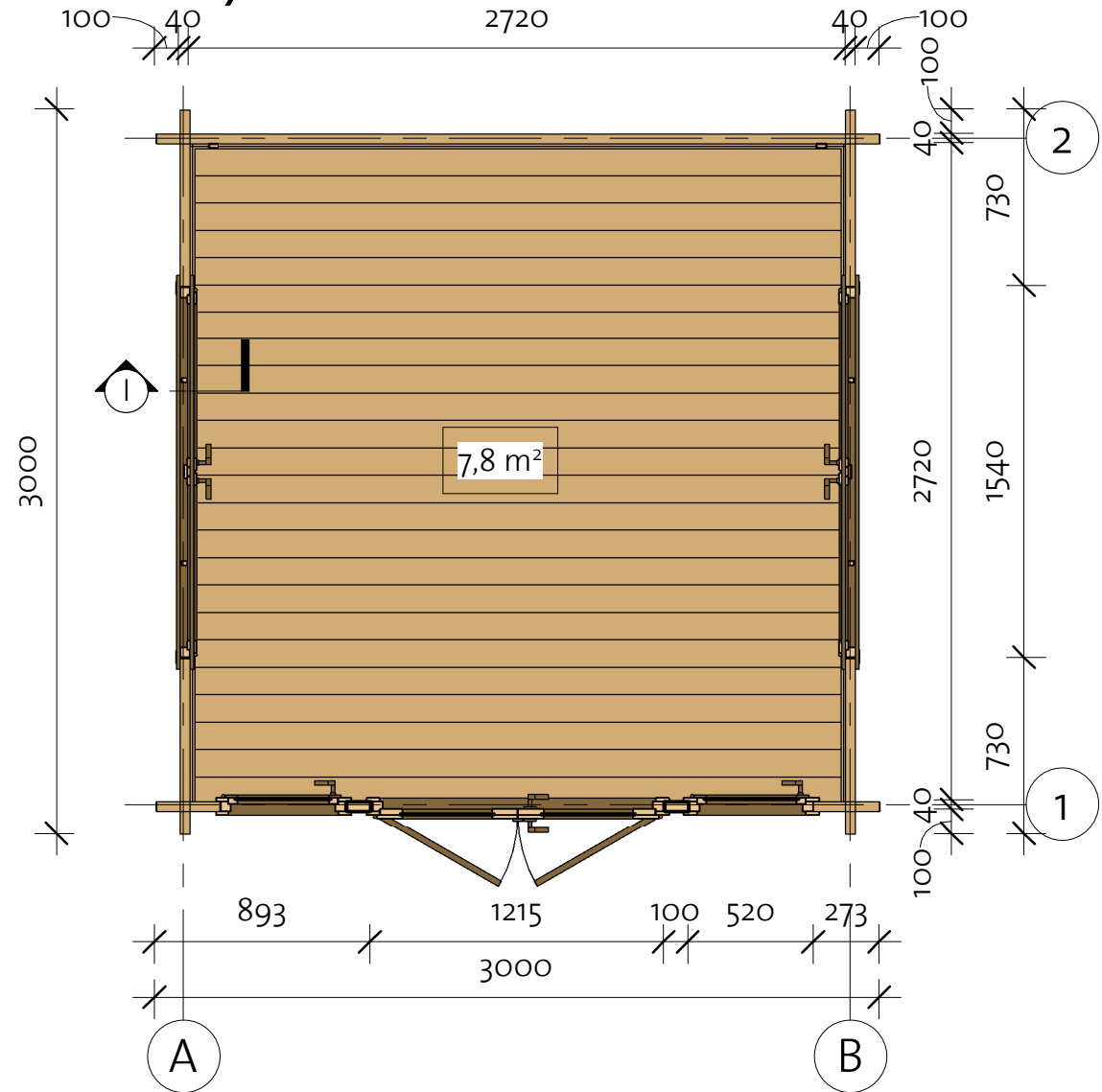

Summertime 40 (280x280)

Wall 1

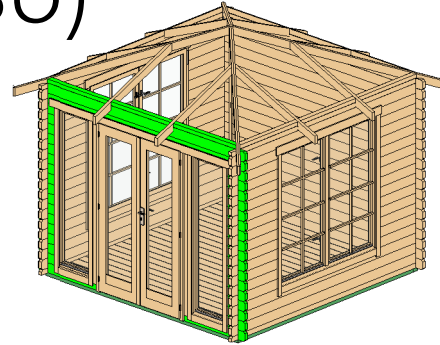

Wall 1			
Mark	Profile	Count	Cut Length

1LG-1	40X114	2	893
1LG-2	40X114	1	3000
1LG-3	40X114	32	273
1LG-4	40X114	1	3000
1TL-1	40X63	1	855
1TL-2	40X63	1	904
1TL-3	40X63	1	904

Columns			
Mark	Profile	Count	Length
CM1	Post 40X100	2	1890

Log Profile Wall 1	
Profile	Profile

40X114	
40X63	

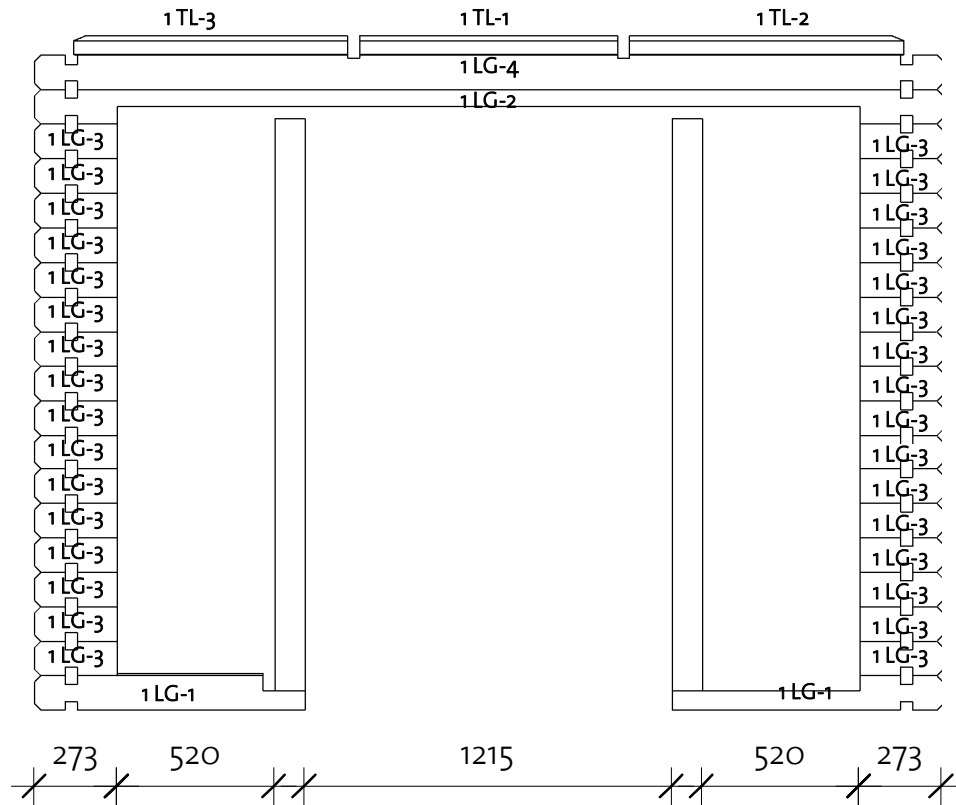

Summertime 40 (280x280)

Wall 2

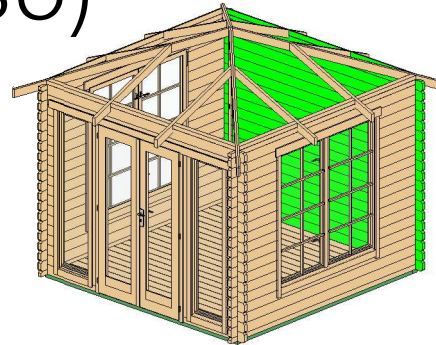

Wall 2			
Mark	Profile	Count	Cut Length

2LG-1	40x114	18	3000
2LG-2	40x114	1	3000
2TL-1	40x63	1	855
2TL-2	40x63	1	904
2TL-3	40x63	1	904

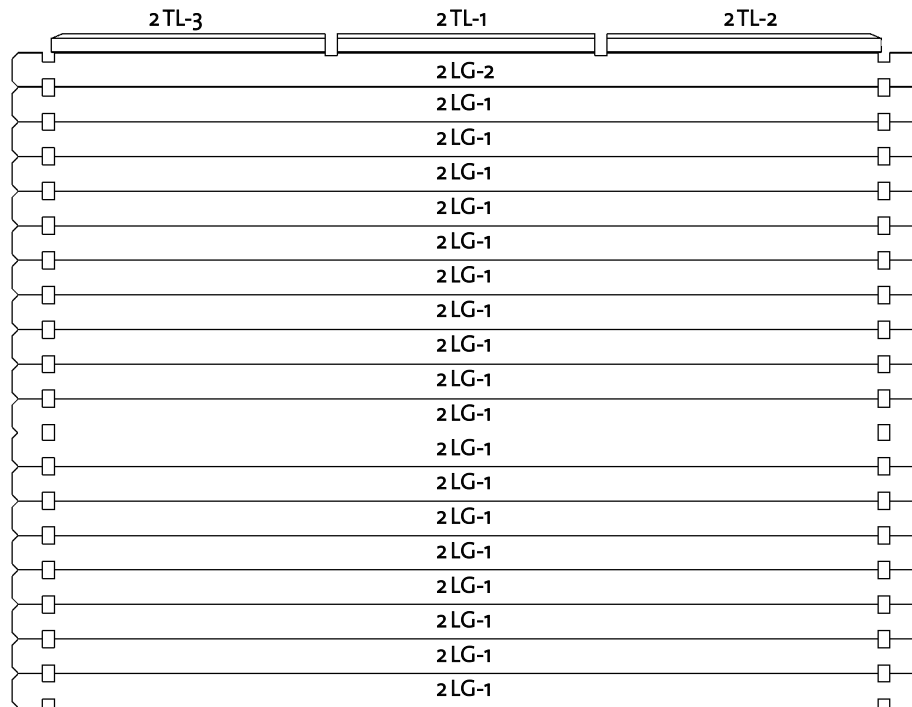

Log Profile Wall 2	
Profile	Profile

40x114	
40x63	

Summertime 40 (280x280)

Wall A

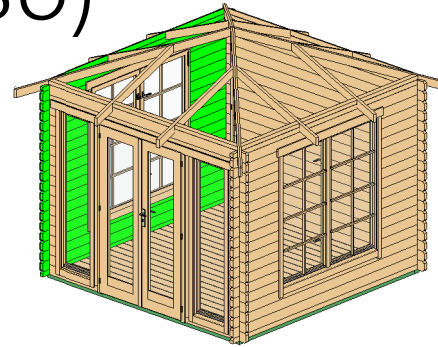



Wall A			
Mark	Profile	Count	Cut Length

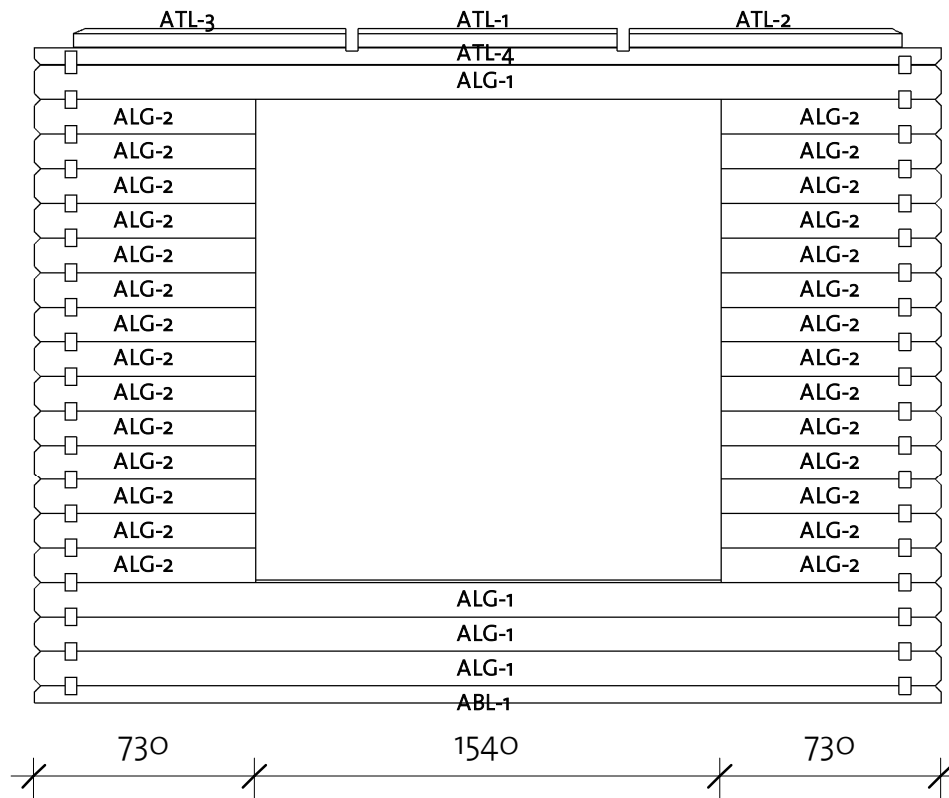

ATL-1	40x63	1	855
ATL-2	40x63	1	904
ATL-3	40x63	1	904
ABL-1	40x57	1	3000
ALG-1	40x114	4	3000
ALG-2	40x114	28	730
ATL-4	40x57 TL	1	3000

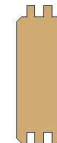

Log Profile Wall A	
Profile	Profile

40x114	
40x63	

Log Profile Wall A	
Profile	Profile

40x57	
40x57 TL	

Summertime 40 (280x280)

Wall B

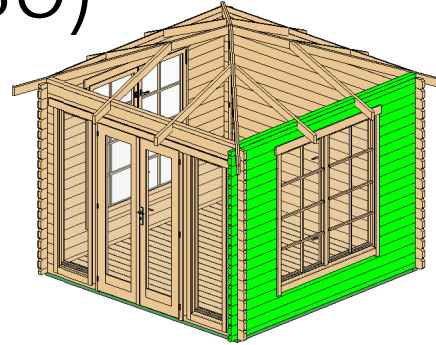



Wall B			
Mark	Profile	Count	Cut Length

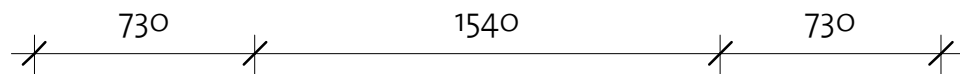
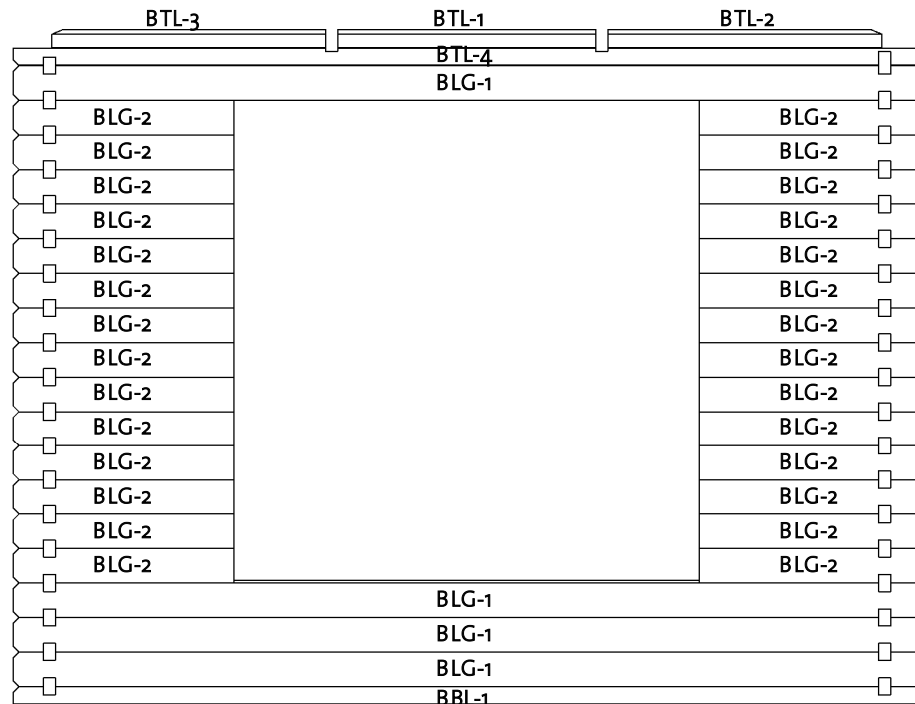

BTL-1	40x63	1	855
BTL-2	40x63	1	904
BTL-3	40x63	1	904
BBL-1	40x57	1	3000
BLG-1	40x114	4	3000
BLG-2	40x114	28	730
BTL-4	40x57 TL	1	3000



Log Profile Wall B	
Profile	Profile

40x57	
40x57 TL	

Log Profile Wall B	
Profile	Profile

40x63	
40x114	

Summertime 40 (280x280)

Roof 1

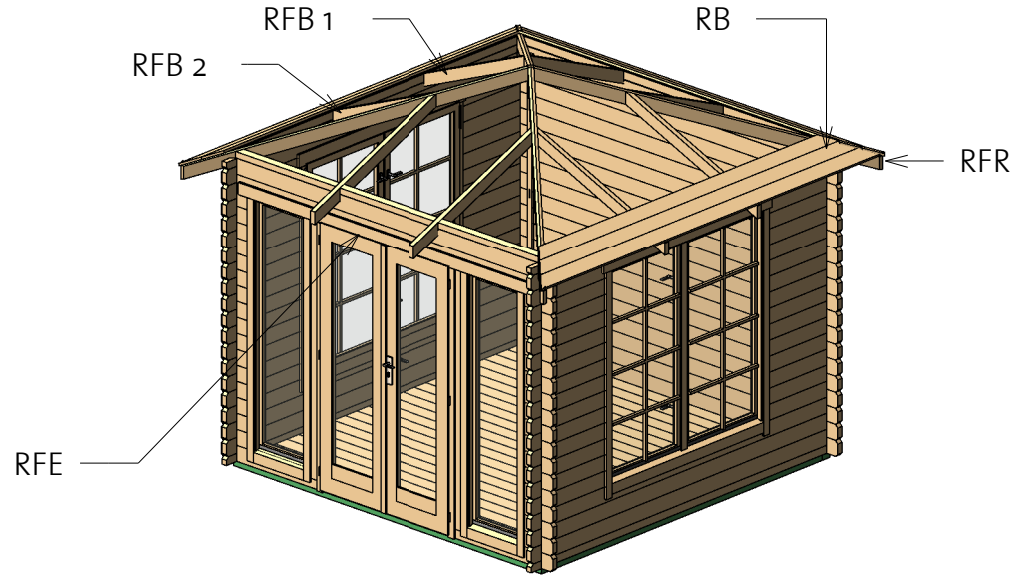

Roof				
Mark	Type	Profile	Count	Length

RFE	18x95		2	2660
RFR	40x94		4	2426
RFB1	40x85		4	1319
RFB2	40x85		4	1319

Roofboards				
Mark	Type	Profile	Count	Length

RB1	RB 17x58		4	123
RB2	RB 17x114		4	334
RB3	RB 17x114		4	544
RB4	RB 17x114		4	755
RB5	RB 17x114		4	966
RB6	RB 17x114		4	1176
RB7	RB 17x114		4	1387

Roofboards				
Mark	Type	Profile	Count	Length

RB8	RB 17x114		4	1597
RB9	RB 17x114		4	1808
RB10	RB 17x114		4	2019
RB11	RB 17x114		4	2229
RB12	RB 17x114		4	2440
RB13	RB 17x114		4	2651
RB14	RB 17x114		4	2861
RB15	RB 17x114		4	3072
RB16	RB 17x114		4	3283

Summertime 40 (280x280)

Roof 2

Fascia Schedule				
Mark	Type	Profile	Count	Length
RF	Roof Fascia 18x120		4	3301

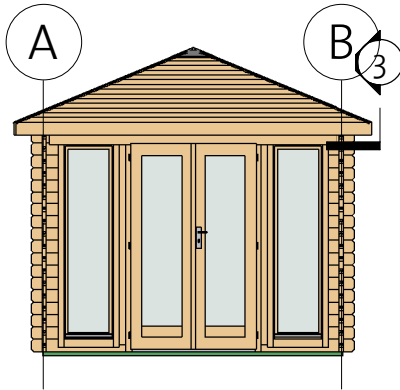

3) Fascia

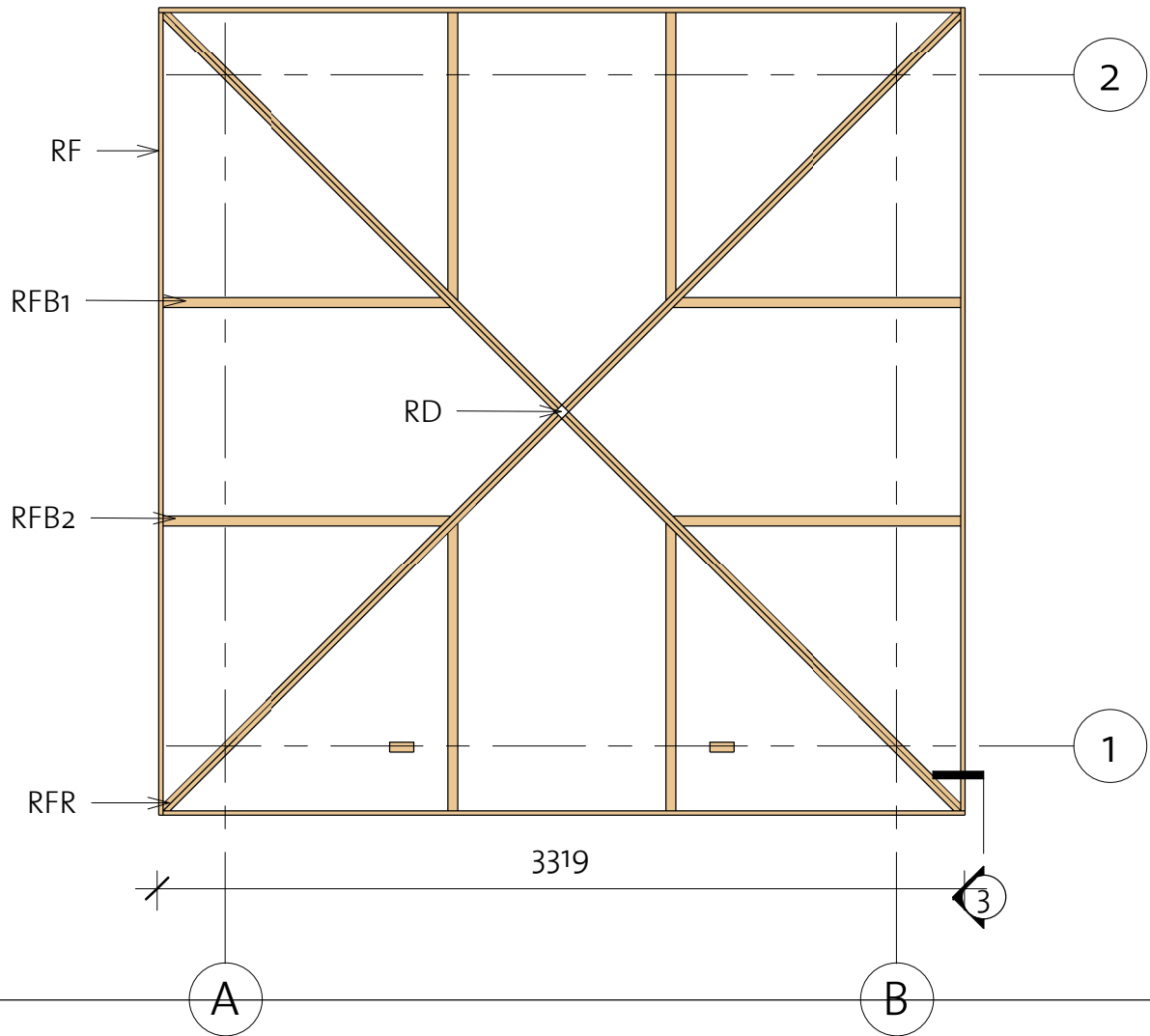
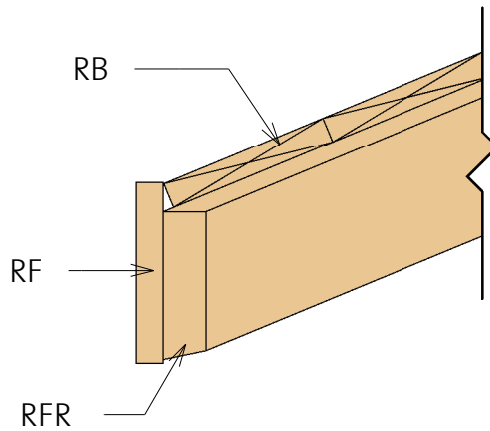

Summertime 40 (280x280)

Extras

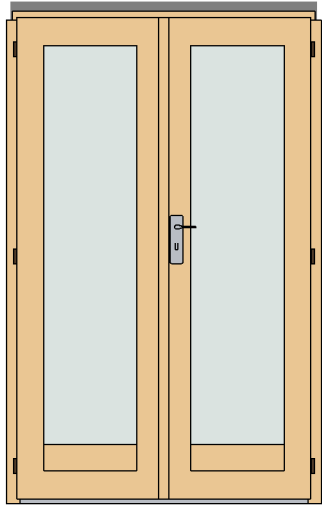

CDD30R	Classic double door 30 right	1215	1995	1
--------	------------------------------	------	------	---

DCB8	Door crossbar 8 optional	--	--	2
------	--------------------------	----	----	---

CDW4	Classic double window 4	1530	1555	2
------	-------------------------	------	------	---

CW21R	Classic window 21 right	515	1890	2
-------	-------------------------	-----	------	---

WCB8	Window crossbar 8 optional	--	--	6
------	----------------------------	----	----	---

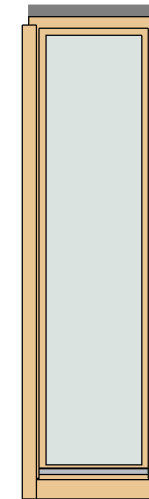
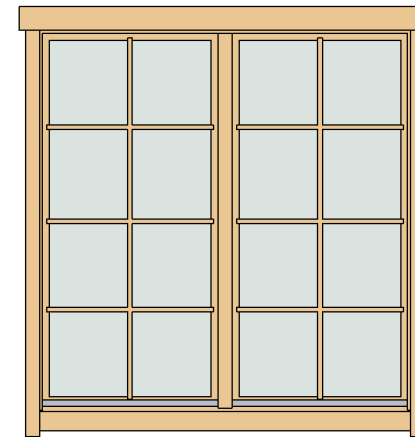

Name	Type	Count
------	------	-------

Bolts	M8 x 70	12
Hitblock	300-400 mm	
Nails	1,4 x 40	30
Screws	4,0 x 40	520
Screws	5,0 x 70	50
Screws	6,0 x 140	50



Type	Count	Lenght
------	-------	--------

Windboard 18x40	4	2200
-----------------	---	------

① Roof top 23°

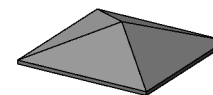

RD	Roof detail	1
----	-------------	---



92307031_230717

Summertime 40 (280x280)

List of all items 1

Impregnated foundation beams

Mark	Type	Profile	Count	Length
------	------	---------	-------	--------

IFB1	IFB 70x40		6	2650
IFB2	IFB 70x40		2	2790



Floor Schedule

Mark	Type	Profile	Count	Length
------	------	---------	-------	--------

FB	FB 17x114		25	2714
----	-----------	---	----	------

Roof

Mark	Type	Profile	Count	Length
------	------	---------	-------	--------

RFE	18x95		2	2660
RFR	40x94		4	2426
RFB1	40x85		4	1319
RFB2	40x85		4	1319

Fascia Schedule

Mark	Type	Profile	Count	Length
------	------	---------	-------	--------

RF	Roof Fascia 18x120		4	3301
----	-----------------------	---	---	------

Roofboards

Mark	Type	Profile	Count	Length
------	------	---------	-------	--------

RB1	RB 17x58		4	123
RB2	RB 17x114		4	334
RB3	RB 17x114		4	544
RB4	RB 17x114		4	755
RB5	RB 17x114		4	966
RB6	RB 17x114		4	1176
RB7	RB 17x114		4	1387

Roofboards

Mark	Type	Profile	Count	Length
------	------	---------	-------	--------

RB8	RB 17x114		4	1597
RB9	RB 17x114		4	1808
RB10	RB 17x114		4	2019
RB11	RB 17x114		4	2229
RB12	RB 17x114		4	2440
RB13	RB 17x114		4	2651
RB14	RB 17x114		4	2861
RB15	RB 17x114		4	3072
RB16	RB 17x114		4	3283

Summertime 40 (280x280)

List of all items 2

Wall 1			
Mark	Profile	Count	Cut Length

1LG-1	40x114	2	893
1LG-2	40x114	1	3000
1LG-3	40x114	32	273
1LG-4	40x114	1	3000
1TL-1	40x63	1	855
1TL-2	40x63	1	904
1TL-3	40x63	1	904

Wall A			
Mark	Profile	Count	Cut Length

ATL-1	40x63	1	855
ATL-2	40x63	1	904
ATL-3	40x63	1	904
ABL-1	40x57	1	3000
ALG-1	40x114	4	3000
ALG-2	40x114	28	730
ATL-4	40x57 TL	1	3000



Wall 2			
Mark	Profile	Count	Cut Length

2LG-1	40x114	18	3000
2LG-2	40x114	1	3000
2TL-1	40x63	1	855
2TL-2	40x63	1	904
2TL-3	40x63	1	904

Wall B			
Mark	Profile	Count	Cut Length

BTL-1	40x63	1	855
BTL-2	40x63	1	904
BTL-3	40x63	1	904
BBL-1	40x57	1	3000
BLG-1	40x114	4	3000
BLG-2	40x114	28	730
BTL-4	40x57 TL	1	3000

Log Profiles	
Profile	Profile

40x63	
40x114	

Log Profiles	
Profile	Profile

40x57	
40x57 TL	